

# Relay Basics

## Part 1

Single Pole, Single Throw - S.P.S.T



Single Pole Double Throw - S.P.D.T.

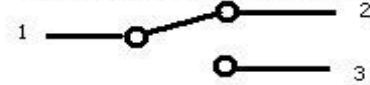

Double Pole, Double Throw - D.P.D.T

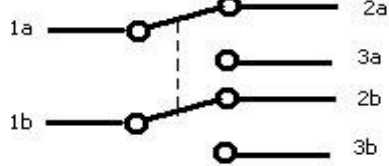

Please understand that a relay is exactly the same switching concept as a hand operated switch. Except its done electrically.

Normally Closed Contact - N/C

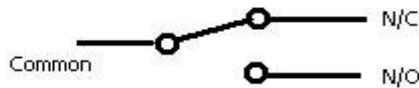

Normally Open Contact - N/O

Two Single Throw Single Throw toggle switches. One acts as headlight switch and one acts as dimmer switch (foot switch?)

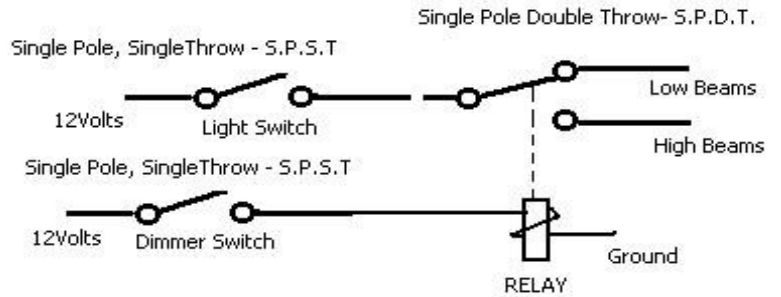

Single Pole, Single Throw - S.P.S.T

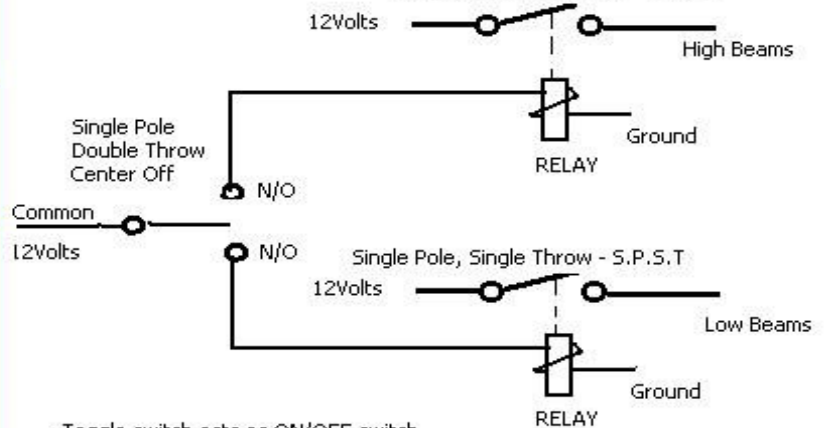

Toggle switch acts as ON/OFF switch and as DIMMER switch.

DLM 8-28-2002

Switches And Relays

# Relay Basics

## Part 2

How relay handles current load so control switch can be minimal specification and current rated.

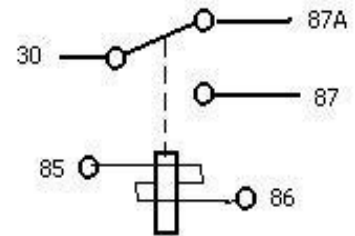
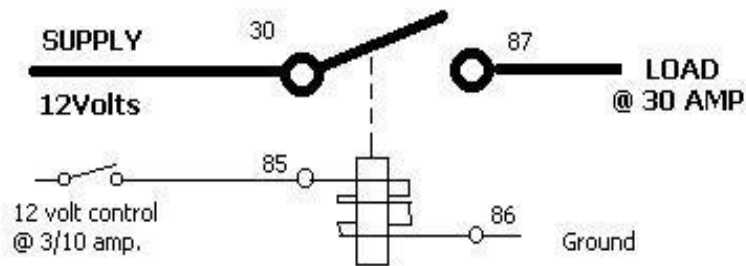

Single Pole Double Throw relay- typical of automotive style.

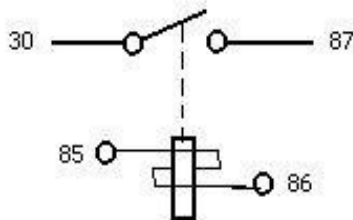

Four terminal case style.

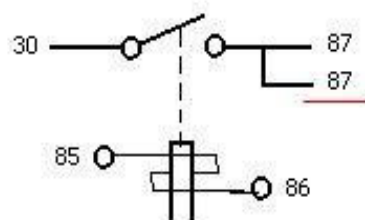

Five terminal case style.

Do not confuse SPST 5 terminal case style with SPDT 5 terminal case style

Typical Single Pole Single Throw relay - typical of automotive applications

DLM 8-28-2002

Switches and Relays II